

- KAWASAKI Z125 PRO ('16 on)
- HONDA MSX125 GROM ('14 on)
- HONDA CT125 ('20 on)

Preparation: KAWASAKI Z125 PRO

Remove original bar end plug.

Fitting Procedure:

Fitting Procedure shown for the LEFT side

(repeat for RIGHT side with applicable parts)

- Loosely assemble clamp (3) below the bend of the handlebar and position as shown in image below.
- Loosely attach the handguard backbone with applicable parts to the handlebar end and also to the clamp.
- **Note:** The preferred backbone position is horizontal when viewed from the side.
- Tighten all bolts in the following order (8), then (7), then (5 and 6).
- Use recommended torque specifications over page.

Kawasaki Z125 PRO

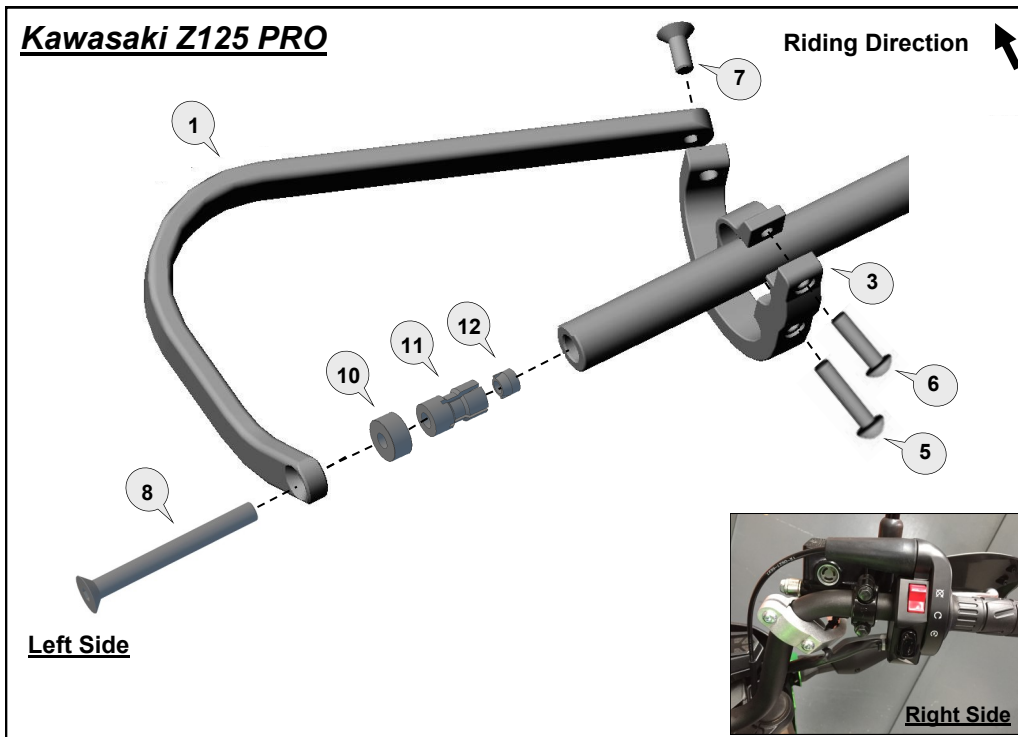

FITTING TIP: Kawasaki Z125 PRO

Clamp is positioned below the bend of the handlebar as shown.

Preparation: HONDA MSX125 GROM

Remove original handlebar end weight and screw. **NOTE:** Retain original weight.

Fitting Procedure:

Fitting Procedure shown for the RIGHT side

(repeat for LEFT side with applicable parts)

- Loosely assemble clamp (4) to the handlebar with applicable parts.
- **FITTING TIP:** Clamp is positioned at the handlebar bend.
- Loosely attach the handguard backbone with applicable parts to the handlebar end and also to the clamp.
- **Note:** The preferred backbone position is horizontal when viewed from the side.
- Tighten all bolts in the following order (9), then (7), then (5 and 6).
- Use recommended torque specifications over page.

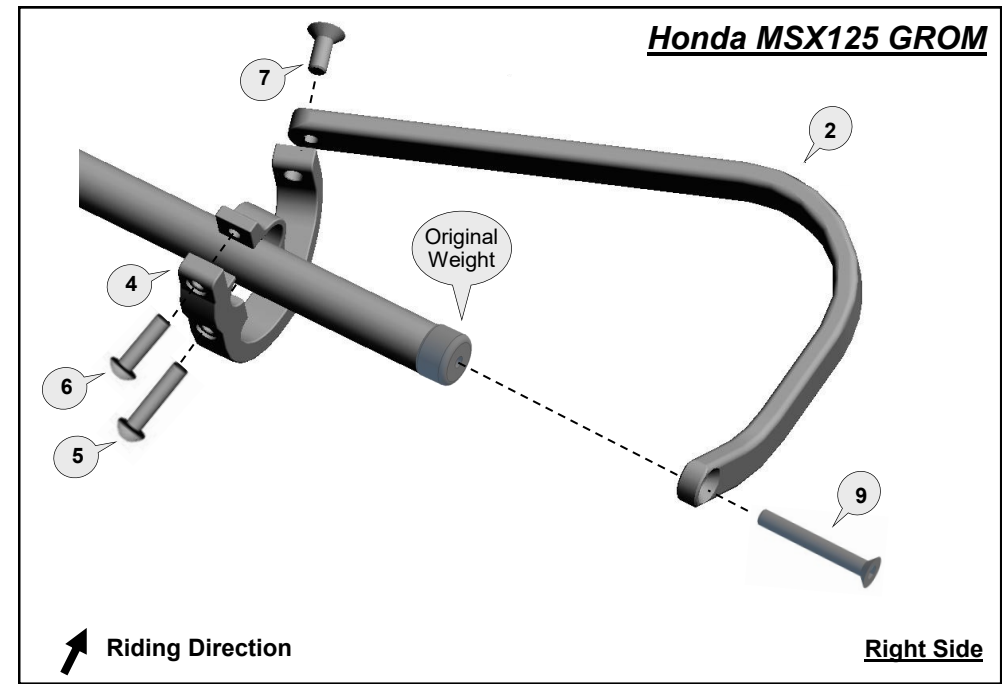

Preparation: Honda CT125

Remove original handlebar end weight with internal weight parts.

Left side, roll back hand grip and depress the two retaining clips through the holes in the handlebar with a screwdriver. There is one top and one bottom. To access holes on right side, unscrew throttle housing and separate the two halves enough to slide the twist grip in from the end. Leave handlebar weight connected to the internal weight to help with removing the internal parts. Pull on weight while pressing clips through hole. *See images below.*

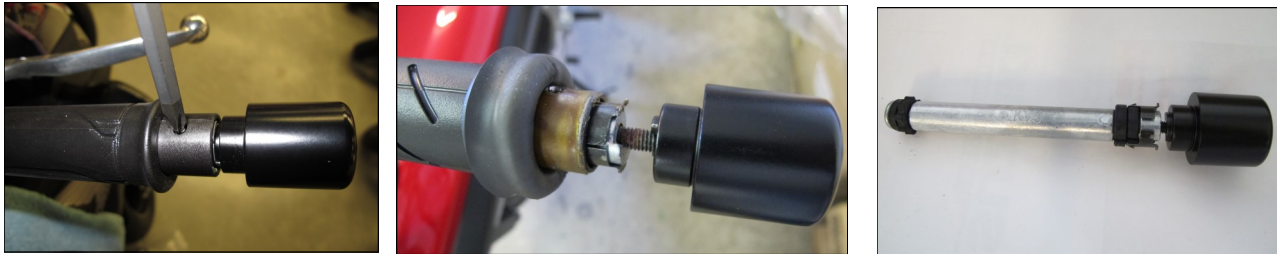

Fitting Procedure:

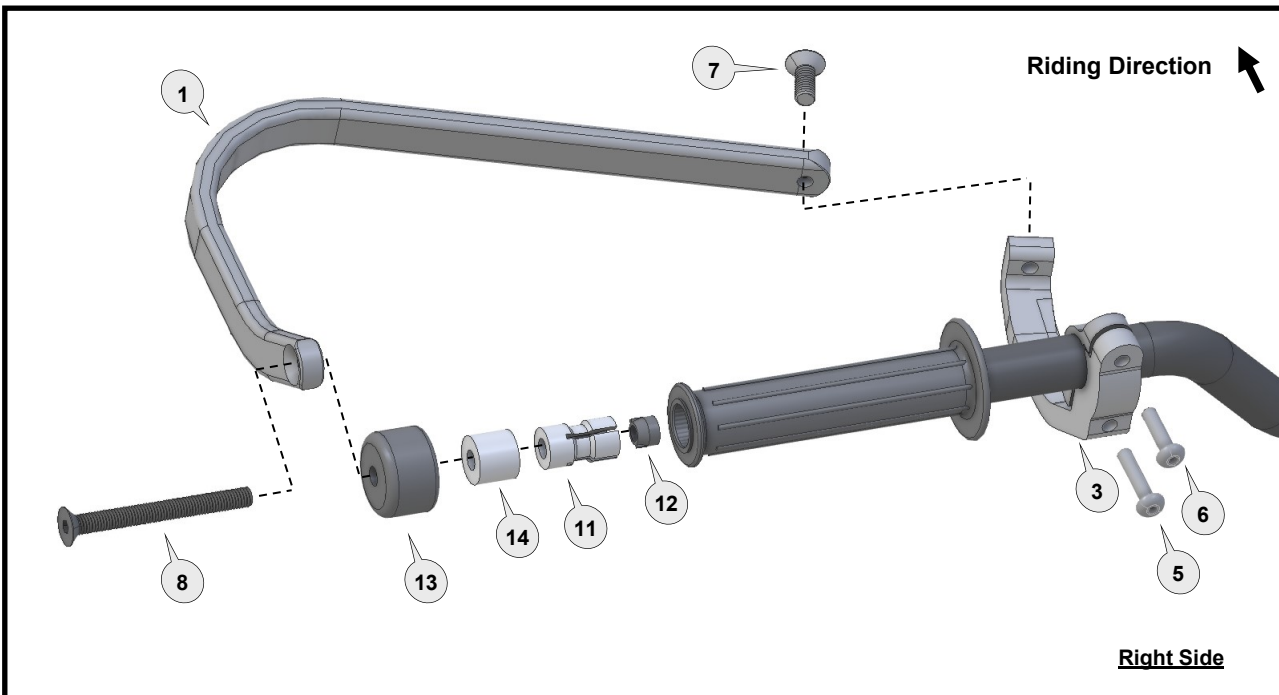











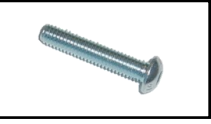

Fitting Procedure shown for the LEFT side
(repeat for RIGHT side with applicable parts)

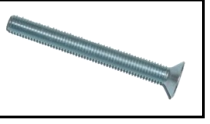
- Loosely assemble clamp (3) to the handlebar with applicable parts.
- Loosely attach the handguard backbone with applicable parts to the handlebar end and also to the clamp.

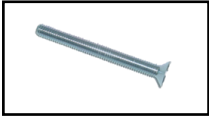
Note: The preferred backbone position is horizontal when viewed from the side.

- Tighten all bolts in the following order (8), then (7), then (5 and 6).
- Use recommended torque specifications over page.

1 Aluminium Bar  PN: BAR-V-020-L Pcs. 1 Left	2 Aluminium Bar  PN: BAR-V-020-R Pcs. 1 Right	3 Clamp Frame & Saddle LEFT  PN: CFS-ADV-L Pcs. 1 set	4 Clamp Frame & Saddle RIGHT  PN: CFS-ADV-R Pcs. 1 set	5 Button Head Bolt 30mm  PN: M6X30BHCSZP Pcs. 2	6 Button Head Bolt 20mm  PN: M6X20BHCSZP Pcs. 2	7 Flat Head Bolt 20mm  PN: M8X20FHCSZP Pcs. 2	8 Flat Head Bolt 75mm  PN: M8X75FHCSZP Pcs. 2
--	---	--	--	---	---	---	---

9 Flat Head Bolt 60mm  PN: M6X60FHCSZP Pcs. 2	10 Spacer  PN: BSSRT20 Pcs. 2	11 Expander  PN: BBE17 Pcs. 2	12 Taper Nut  PN: NUT12 Pcs. 2	13 Bar End Weight  PN: BEW35 Pcs. 2	14 Spacer  PN: SP17-20-8 Pcs. 2
---	---	---	---	---	---

Personalise Your Protection
Guard options sold separately

JET JET-003
VPS VPS-003
Storm STM-003
CARBON BCF-003

See below for correct bar orientation

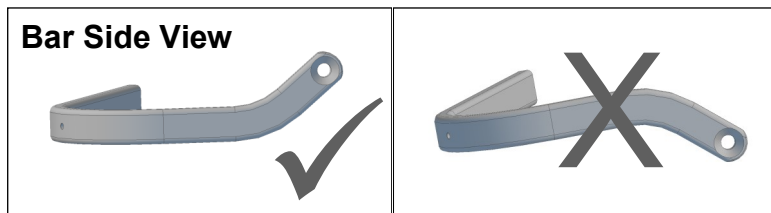

Recommended Torque Settings	
M6	10 Nm (7.4 lbf ft)
M8	20 Nm (14.8 lbf ft)



Email: info@barkbusters.net
 Web: www.barkbusters.net



CAUTION:

Installation of the handguard is safety-relevant work and can be complicated. We recommend the installation be performed by a motorcycle service technician. Rideworx accepts no liability for damages caused by improper mounting. All screws, bolts and nuts, including all replacement hardware provided by Rideworx, should be tightened to the torque specified in the table. After the first 50km of riding check all screws, bolts and nuts are tightened to the correct torque. We recommend a medium strength liquid thread lock product on all fasteners.

WARNING:

Check operation of all handlebar controls, specifically the throttle, front brake, kill switch and clutch to ensure they are operating correctly and are in accordance with the OEM specifications. Do not ride the motorcycle if any controls are not operating correctly or if rear view mirror vision is obscured. Check periodically that all bolts are tight.

Disclaimer:

A failure to follow these fitting instructions could cause serious injury, death or property damage. These handguards are intended solely for use with motorcycles/ATV/snowmobiles/scooters that have not been modified. They are not designed to prevent injury or death while riding or in an accident or crash. The user must ensure that all controls are free of the handguards every time that they ride. By installing and/or using this product you acknowledge that you accept these terms and have followed the fitting instructions.