



FITTING INSTRUCTIONS for...

www.barkbusters.net

Preparation

Remove original handguards if fitted.

RIGHT SIDE

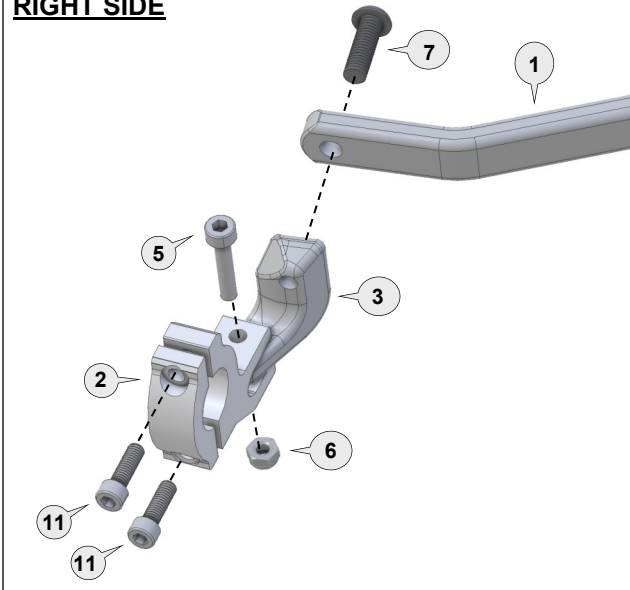

RIGHT SIDE

*KTM 390 Adventure
Yamaha XT660R*

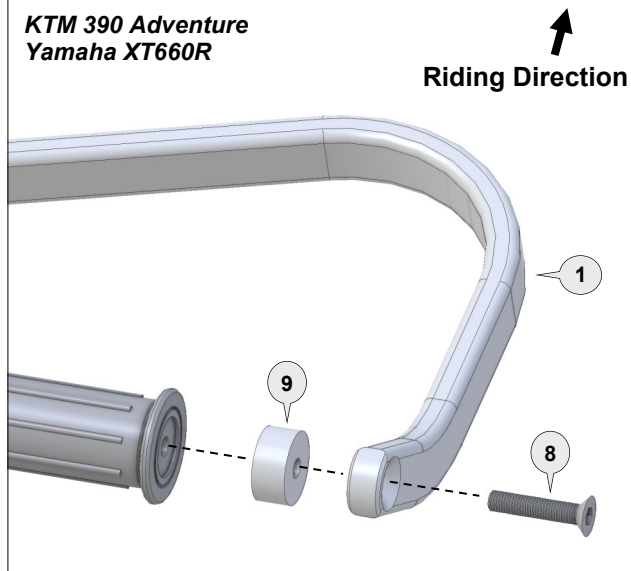

Installation for Right Side.

Repeat for Left side with applicable parts.

- Loosely assemble the clamp to the handlebar as per diagram.
- Attach the handguard backbone (1) with applicable parts to the handlebar end and also to the clamp connector (3).
- Position backbone so it is horizontal when viewed from the side.
- Tighten all bolts in the following order: (8 or 10), (7), (11) then (5).

Important: Use the specified torque setting over page.

RIGHT SIDE

*ROYAL ENFIELD Himalayan
BAJAJ Dominar 400*

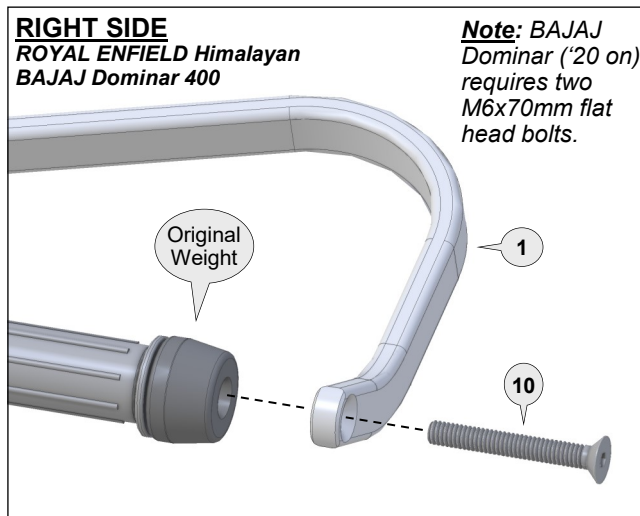

- KTM 390 Adventure ('20 on)*
- ROYAL ENFIELD Himalayan ('16 on)*
- YAMAHA XT660R ('04 on)*
- BAJAJ Dominar 400*

IMPORTANT FITTING TIP For Himalayan:

To avoid the handguard making contact with the windscreen when the steering is at full lock, it is necessary to position the windscreen in the forward position.

See below image for screw location.













For Maximum Clearance

With the four screws loose, gently push forward at the top of the windscreen while tightening the screws.

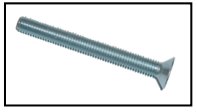

Phone: +61 (0)2 4271 8244
Email: info@barkbusters.net

<p>1 Aluminium Bar</p>  <p>PN: BAR-V-030 Pcs. Left/Right Pair</p>	<p>2 Multi Fit Clamp 22mm</p>  <p>PN: MFC-22 Pcs. 2</p>	<p>3 Connector RIGHT</p>  <p>PN: CP8-R Pcs. 1</p>	<p>4 Connector LEFT</p>  <p>PN: CP8-L Pcs. 1</p>	<p>5 Socket Head Bolt 30mm</p>  <p>PN: M6X30SHCSZP Pcs. 2</p>	<p>6 Nylock Nut 6mm</p>  <p>PN: M6LN Pcs. 2</p>	<p>7 Button Head Bolt 25mm</p>  <p>PN: M8X25BHCSZP Pcs. 2</p>	<p>8 Flat Head Bolt 35mm</p>  <p>PN: M6X35FHCSZP Pcs. 2</p>
---	---	---	---	---	---	---	---

<p>9 Spacer</p>  <p>PN: SP10-22-6 Pcs. 2</p>	<p>10 Flat Head Bolt 75mm</p>  <p>PN: M8X75FHCSZP Pcs. 2</p>	<p>11 Socket Head Bolt 20mm</p>  <p>PN: M6X20SHCSZP Pcs. 4</p>
--	--	--

Personalise Your Protection
Guard options sold separately

JET JET-003
VPS VPS-003
Storm STM-003
CARBON BCF-003

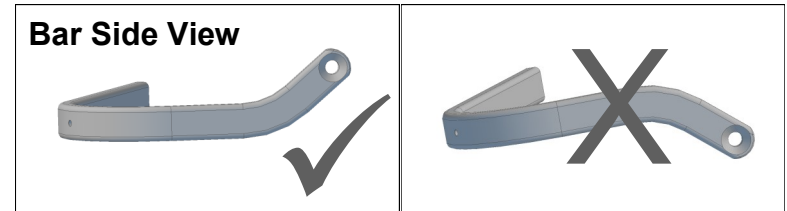

Recommended Torque Settings	
M6	10 Nm (7.4 lbf ft)
M8	20 Nm (14.8 lbf ft)

CAUTION:

Installation of the handguard is safety-relevant work and can be complicated. We recommend the installation be performed by a motorcycle service technician. Rideworx accepts no liability for damages caused by improper mounting. All screws, bolts and nuts, including all replacement hardware provided by Rideworx, should be tightened to the torque specified in the table. After the first 50km of riding check all screws, bolts and nuts are tightened to the correct torque. We recommend a medium strength liquid thread lock product on all fasteners.

WARNING:

It is important there is a working clearance (approx 3mm) between the throttle grip end and the handguard to ensure a free closing throttle. Check operation of all handlebar controls, specifically the throttle, front brake, kill switch and clutch to ensure they are operating correctly and are in accordance with the OEM specifications. Do not ride the motorcycle if any controls are not operating correctly. Check periodically that all bolts are tight.

Disclaimer:

A failure to follow these fitting instructions could cause serious injury, death or property damage. These handguards are intended solely for use with motorcycles/ATV/snowmobiles/scooters that have not been modified. They are not designed to prevent injury or death while riding or in an accident or crash. The user must ensure that all controls are free of the handguards every time that they ride. By installing and/or using this product you acknowledge that you accept these terms and have followed the fitting instructions.



Phone: +61 (0)2 4271 8244
Email: info@barkbusters.net
Web: www.barkbusters.net

